



## T6 Pro Smart Programmable Thermostat

TH6220WF2006  
TH6320WF2003

## Professional Install Guide

.....  
**Package Includes:**

- T6 Pro Smart Thermostat
  - UWP™ Mounting System
  - Decorative Cover Plate
  - Screws and anchors
  - Thermostat literature
- .....



**Search for local rebates:** [HoneywellHome.com/Rebates](https://www.honeywellhome.com/Rebates)

## Read before installing

### Compatibility

- Compatible with most heating, cooling, and heat pump systems
- Required: 24 VAC power ("C" wire)
- Input: 24 V ~ @ 60 Hz, 1 A
- Does not work with electric baseboard heat (120V-240V)
- Does not work with millivolt systems
- Android or iOS smartphone or tablet

## Customer assistance

**WEB** [customer.resideo.com](https://customer.resideo.com)

**PHONE** 1-800-633-3991



33-00392-09

# UWP Mounting System installation

1. Open package to find the UWP.  
See Figure 1.
2. Position the UWP on the wall. Level and mark hole positions. See Figure 2.

Drill holes at marked positions, and then lightly tap supplied wall anchors into wall using a hammer.

- If your box contains red anchors, drill  $7/32"$  (5.6 mm) holes for drywall.
- If your box contains yellow anchors, drill  $3/16"$  (4.8 mm) holes for drywall.

3. Pull the door open and insert wires through wiring hole of the UWP. See Figure 3.

4. Place the UWP over the wall anchors. Insert and tighten mounting screws supplied with the UWP. Do not overtighten. Tighten until the UWP no longer moves. Close the door. See Figure 4.

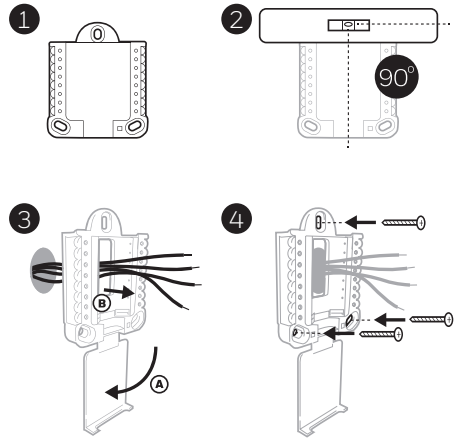

Use 3x supplied screws (#8 1-1/2" [38 mm] for red anchors and #6 1-1/2 [38 mm] for yellow anchors)

# Optional Decorative Cover Plate installation

Use the **Optional Cover Plate** when you need to cover paint gap from the old thermostat.

There are different cover plates depending on when the thermostat was manufactured.

One plate is square, the other is rectangular.

1. Separate the cover plate from the mounting plate. See Figure 1.
2. Mount the mounting plate to the wall using any of the screw holes. Insert and tighten mounting screws supplied with the cover plate. Do not overtighten. Make sure the mounting plate is level. See Figure 2a (square) or 2b (rectangle).
3. Attach the UWP by hanging it on the top hook of the mounting plate and then snapping the bottom of the UWP in place. See Figure 3.
4. Snap the Cover Plate onto the mounting plate. See Figure 4.

If there are no existing wall anchors, you can follow the same instructions for the UWP Mounting System installation to install the cover plate. Just use 2 screws rather than 3.

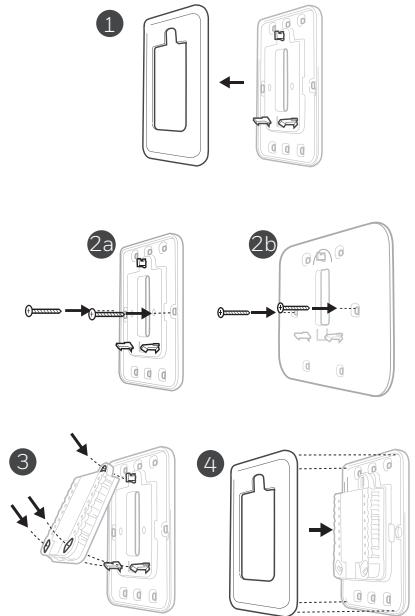

# Wiring UWP

Push down on the tabs to put the wires into the inner holes of their corresponding terminals on the UWP (one wire per terminal) until they are firmly in place. **Gently tug on the wires to verify they are secure.** If you need to release the wires again, push down the terminal tabs on the sides of the UWP.

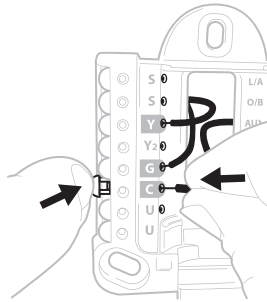

This wiring is just an example, yours may vary.

## Terminal designations

Conventional Systems		Heat pump systems	
Terminal	Description	Terminal	Description
S/S	Input for a wired indoor, outdoor sensor	S/S	Input for a wired indoor, outdoor sensor
Y	Compressor Stage 1	Y	Compressor Stage 1
Y2	Compressor Stage 2	Y2	Compressor Stage 2
G	Fan Relay	G	Fan Relay
C	24VAC Common wire from secondary side of cooling transformer (if 2 transformers)	C	24VAC Common wire from secondary side of cooling transformer
K*	Connect to K on C-wire adaptor	K*	Connect to K on C-wire adaptor
U/U**	Relay for ventilation	U/U**	Relay for ventilation
A		L/A	Connect to compressor monitor
W	Heat Stage 1	O/B	Changeover valve for heat pumps
W2	Heat Stage 2	Aux	Backup Heat
		E	Emergency Heat
R	24 VAC Heating transformer	R	24 VAC Heating transformer
Rc	24 VAC Cooling transformer	Rc	24 VAC Cooling transformer

\* The THP9045A1098 C-wire adaptor is used on heat/cool systems when you only have four wires at the thermostat and you need a fifth wire for a common wire. Use the K terminal in place of the Y and G terminals on conventional or heat pump systems to provide control of the fan and the compressor through a single wire—the unused wire then becomes your common wire. See THP9045 instructions for more information.

\*\* Ventilation is not available on all models. When the U slider is in the down position (2 wires), the U contacts are a dry set of contacts. If your ventilation system requires 24 volts, move the U slider to the up position (1 wire). Lower U terminal is internally jumped to the Rc terminal. In this application, you would hook up one wire from your damper to the upper U terminal and the other to the common side of the transformer.

# Setting Slider Tabs

## Set R Slider Tab, see Figure 9.

- Use built-in jumper (**R Slider Tab**) to differentiate between one or two transformer systems.
- If there is only one R wire, and it is connected to the **R**, **Rc**, or **RH** terminal on the old thermostat, set the slider to the **up** position (**1 wire**).
- If there is one wire connected to the **R** terminal and one wire connected to the **Rc** terminal, set the slider to the **down** position (**2 wires**).

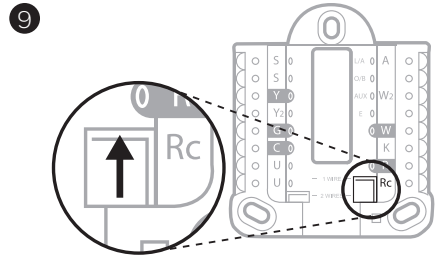

## Set U Slider Tab, see Figure 10.

- Use built-in jumper (**U Slider Tab**) of relay to wire ventilation. Please note that ventilation is not supported on all models.
- When the **U Slider Tab** is in the down position (**2 wires**) the U contacts are a dry set of contacts.
- If the ventilator is powered by the cooling transformer, move the jumper switch to the up position (**1 wire**). With this switch set to **1 wire**, the lower **U** terminal is internally jumped to the **Rc** terminal. In this application, hook up one wire from the vent damper to the **U** terminal and the other to the common side of the cooling system transformer.

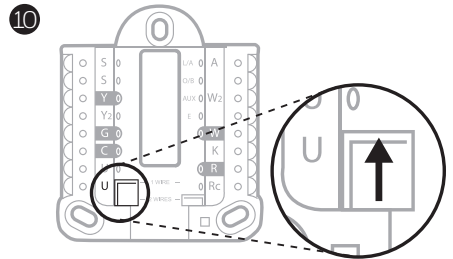

# Wiring

## NOTES:

- 1 Available wiring configurations differ by product models/product numbers.
- 2 Use 18- to 22- gauge thermostat wire. Shielded cable is not required.
- 3 Set the R Slider Tab on the UWP to the up position (1 wire) for 1 transformer systems or the down position (2 wires) for 2 transformer systems. See "Setting Slider Tabs" on page 4.
- 4 Set the U Slider Tab to the up position (1 wire) for non-powered ventilation or the down position (2 wires) for powered ventilation. See "Setting Slider Tabs" on page 4.

## Conventional systems

### 1H/1C System (1 transformer)

- R** Power
- Rc** [R+Rc joined by Slider Tab]
- Y** Compressor contactor
- C** 24VAC common
- W** Heat relay
- G** Fan relay

### 1H/1C System (2 transformers)

- R** Power (heating transformer)
- Rc** Power (cooling transformer)
- Y** Compressor contactor
- C** 24 VAC common from cooling transformer
- W** Heat relay
- G** Fan relay

### 2H/2C System (1 transformer)

- R** Power
- Rc** [R+Rc joined by Slider Tab]
- Y** Compressor contactor (stage 1)
- C** 24VAC common
- W** Heat relay (stage 1)
- G** Fan relay
- W2** Heat relay (stage 2)
- Y2** Compressor contactor (stage 2)

### Hot Water Relay Panel

- R** Power
- Rc** [R+Rc joined by Slider Tab]
- W** Heat Relay
- C** 24VAC common

**NOTE:** If the panel does not provide 24 volts AC at R and C, set the slider to down position and wire a separate transformer to Rc and C.

### Heat-only System with Fan

- R** Power
- Rc** [R+Rc joined by Slider Tab]
- C** 24VAC common
- W** Heat relay
- G** Fan relay

### Cool-only System with Fan

- R** Power
- Rc** [R+Rc joined by Slider Tab]
- Y** Compressor contactor
- C** 24VAC common
- G** Fan relay

# Heat pumps systems

## 1H/1C Heat Pump System

- R** Power
- Rc** [R+Rc joined by Slider Tab]
- Y** Compressor contactor
- C** 24VAC common
- O/B** Changeover valve
- G** Fan relay

## 2H/1C Heat Pump System

- R** Power
- Rc** [R+Rc joined by Slider Tab]
- Y** Compressor contactor
- C** 24VAC common
- O/B** Changeover valve
- G** Fan relay
- Aux** Auxiliary heat\*
- E** Emergency heat relay\*
- L** Heat pump fault input

**NOTE:** If dual fuel, TH6320WF2003 model needed.

## 2H/2C Heat Pump System

- R** Power
- Rc** [R+Rc joined by Slider Tab]
- Y** Compressor contactor (stage 1)
- C** 24VAC common
- O/B** Changeover valve
- G** Fan relay
- Y2** Compressor contactor (stage 2)
- L** Heat pump fault input

## 3H/2C Heat Pump System

- R** Power
- Rc** [R+Rc joined by Slider Tab]
- Y** Compressor contactor (stage 1)
- C** 24VAC common
- O/B** Changeover valve
- G** Fan relay
- Aux** Auxiliary heat\*
- E** Emergency heat relay\*
- Y2** Compressor contactor (stage 2)
- L** Heat pump fault input

**NOTE:** TH6320WF2003 only.

**NOTE:** Do **NOT** use **W** for heat pump applications. Auxiliary heat must wire to **AUX** or **E**.

\* If you do not have separate wires for the Aux and E terminals, connect the wire to the Aux terminal.

# Ventilation systems

**NOTE:** Ventilation is not available on all models.

## Using U Slider Tab

**Wired to ERV/HRV whole house ventilator with internal power supply.**

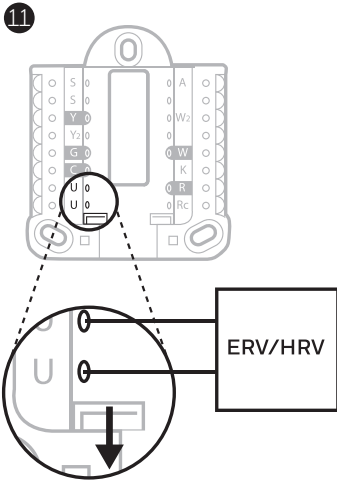

**Wired to fresh air damper powered by furnace transformer.**

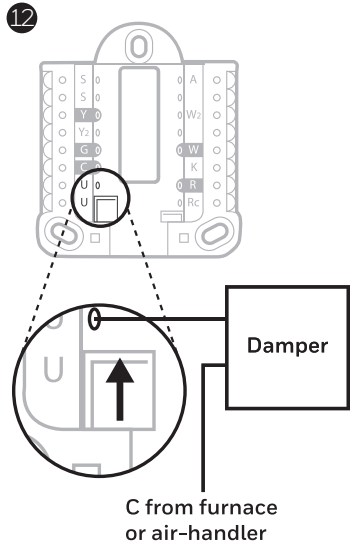

## Mounting thermostat

- 1 Push excess wire back into the wall opening.
- 2 Close the UWP door. It should remain closed without bulging.
- 3 Align the UWP with the thermostat, and push gently until the thermostat snaps in place.
- 4 If needed, gently pull to remove the thermostat from the UWP.
- 5 **Search for local rebates:**  
Your thermostat may now be eligible for local rebates. Search for offers in your area at [HoneywellHome.com/Rebates](https://www.honeywellhome.com/rebates)

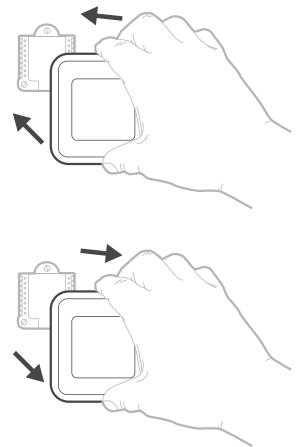

# Installer setup – using the thermostat

## Setup using the thermostat

- After the thermostat has powered up, touch **START SETUP** on the thermostat. You'll be asked if you want to perform setup via app. Touch **No**.
- Touch ⏪ or ⏩ to toggle between Installer Set Up (ISU) options.
- Touch **Edit** or touch text area, and then touch ⏪ or ⏩ to edit default setup option.
- Touch **Done** or touch text area to confirm the setting or press **Cancel**.
- Touch ⏪ or ⏩ to continue to setup another ISU option.

### NOTES:

- To see a list of all setup parameters, go to "Installer setup options (ISU) – advanced menu" on page 11. The thermostat displays the ISU name and the ISU number.
- To finish setup and save your settings, scroll to the **Finish** screen at the end of the ISU list.
- Touch **Select** or touch text area to save changes and exit, or touch ⏪ to return to initial setup screen.

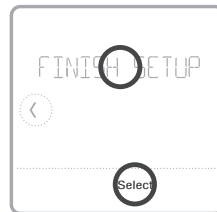
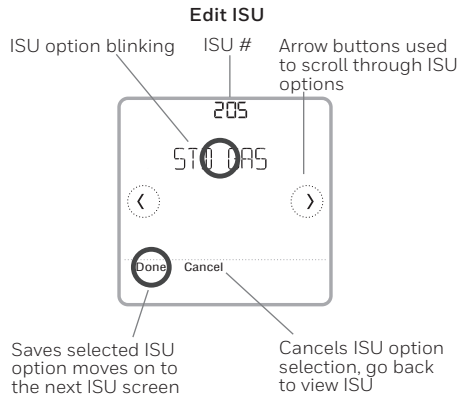
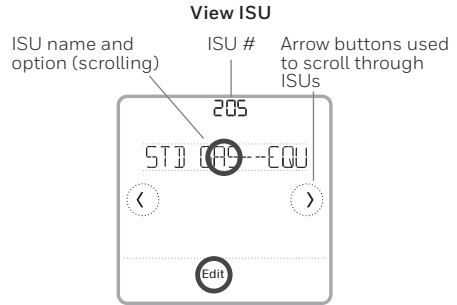
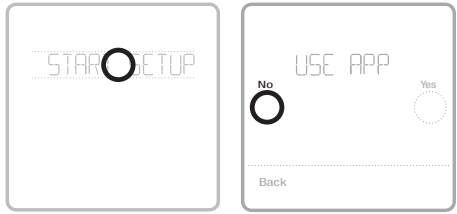



# Installer setup – using the Honeywell Home app

## Setup using the app

Download the Honeywell Home app from App Store or Google Play to use a hidden PRO installation feature that will allow you to configure the thermostat and personally invite your customer to connect to the installed thermostat at the same time.

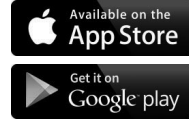

## Enter Contractor Mode

To enter Contractor Mode, press and hold the **Honeywell Home logo** for **5 seconds**. Then tap **Confirm** to begin using Contractor Mode. Follow steps to personally invite your customer to connect their Honeywell Home App.

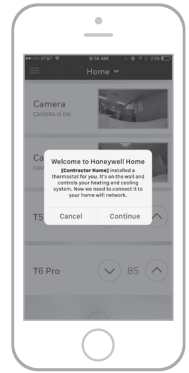
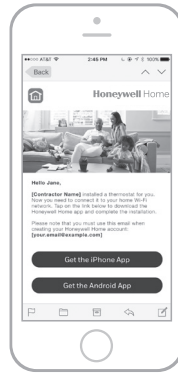
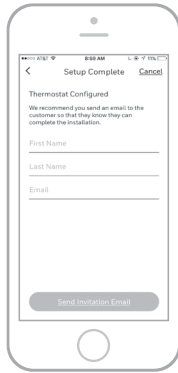

## Installer setup – advanced menu

To access the advanced menu, press and hold the **Menu** button for **5 seconds**. Touch **◀** or **▶** to go through the options in the advanced menu.

## Advanced menu options

### Device Setup

This is used to access the device ISU setting.

### Screen Lock

The thermostat touch screen can be set to lock fully or partially.

### Rater View

A read only place to view all the ventilation settings.

### System Test

Test the heating and cooling system.

### Range Stop (Temperature)

Set the minimum, maximum, cool and heat temperature set points.



## Reset

Access all reset options on the thermostat. This is the only place to access factory reset.

# Key features

## System status information

Cool On, Heat On  
Emergency Heat On,  
Recovery, or Auto  
Changeover On.

## Schedule information

Following time-based  
or location-based  
temperature control.

## Desired Temperature

Displays the current  
desired temperature  
setting.

## Indoor Temperature

Displays the current  
indoor temperature.

## Mode

Select system mode:  
Auto/Heat/Cool/Off/EM  
Heat (Emergency Heat).

## Time, ISU #, or Alert #

## Connection status information

Status of Wi-Fi  
Connection: Connected,  
Disconnected, or Wi-Fi  
is Off.

## Messaging

Shows device setup  
options, menu options,  
reminders, schedule  
overrides.

## Schedule period

Shows schedule period:  
Wake/Away/Home/  
Sleep.

## Fan

Select Fan mode Auto/  
On/Circulate.

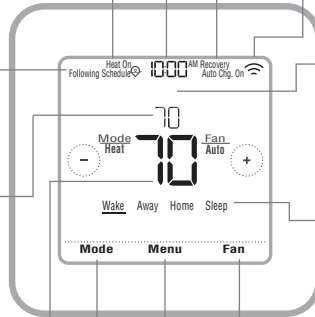

## Menu

Touch to display  
options. Start here  
to set a program  
schedule.

**Note: Long press of  
Menu button for 5  
seconds to access  
Advanced Menu  
options.**

The screen will wake up by pressing the center area of the displayed temperature. The screen will stay lit for 45 seconds. Brightness can be adjusted in the Menu.

# Installer setup options (ISU) – advanced menu

**Table 1.**

**Note:** ISU options available may vary upon the thermostat model and equipment setup.

# ISU	ISU Name	ISU Options (defaults in bold)	Notes
120	Schedule Type	No Schedule MO-SU = Every day the same MO-FR, SA, SU = 5-1-1 schedule <b>MO-FR, SA-SU = 5-2 schedule</b> Each Day = Every day/individual	You can change default MO-FR, SA-SU schedule here. To edit periods during days, temperature setpoints, or to turn Schedule On/Off, from the home screen, go to <b>MENU/SCHEDULE</b> .
125	Temp Scale	<b>Fahrenheit</b> , Celsius	
130	Outdoor Temp	<b>No</b> , Wired, Internet	Select outdoor temperature data source. This ISU automatically defaults to internet when registered to Honeywell Home app and no wired outdoor sensor is selected. We recommend using a wired outdoor sensor connected to the "S" terminals on the UWP. (See "Wiring" on page 5) An outdoor temperature is required to set the following ISUs: ISU 355 Compressor Lockout, ISU 356 Aux Heat Lockout, ISU 1013 Low Outdoor Temperature Ventilation Lockout, ISU 1014 High Outdoor Temperature Ventilation Lockout, and ISU 1015 High Outdoor Dew Point Ventilation Lockout.
200	System Type	<b>Conventional Forced Air</b> Heat Pump Boiler Cool Only	Basic selection of system your thermostat will control.
205	Equipment Type	<i>Conventional/Forced Air Heat:</i> Standard Gas (STD GAS), <b>High Efficiency Gas (EFF GAS)</b> , Oil, Electric, Fan Coil*  <i>Heat Pump:</i> Air To Air, Geothermal  <i>Boiler:</i> <b>Hot Water, Steam</b>	This option selects the equipment type your thermostat will control. Note: This option is <b>NOT</b> displayed if ISU 200 is set to Cool Only. *Fan coil setting is for a residential application with a hot water coil in an air handler.
218	Reversing Valve	<b>O/B on Cool</b> , O/Bon Heat	This ISU is only displayed if ISU 200 is set to Heat Pump. Select whether reversing valve O/B should energize on cool or on heat
220	Cool Stages (#200=Conv./200=HP)	0, <b>1</b> , 2	Only 1 compressor stage available on TH6220WF model if configured for heat pump.
221	Heat Stages/Aux/E Stages (#200=Conv./200=HP)	Heat Stages: 0, <b>1</b> , 2 AUX/E Stages: <b>0</b> , 1	Maximum of 2 Heat Stages for conventional systems. Maximum of 1 Aux/E stages for heat pump systems.
230	Fan Control	Equipment, <b>Thermostat</b>	This ISU is only displayed if ISU 205 is set to Electric Forced Air or Fan Coil.
253	Aux/E Control	<b>Both Aux/E</b> , Either Aux/E	Set "EITHER AUX/E" if you want to setup and control Auxiliary and Emergency heating separately. This ISU is only displayed if ISU 200 is set to Heat Pump AND if ISU 221 Aux/E stages = 1. Note: This ISU available on TH6320 model only.

# Installer setup options (ISU)– advanced menu

**Table 2.**

# ISU	ISU Name	ISU Options (defaults in bold)	Notes
255	Aux Heat Type	<b>Electric</b> , Gas/Oil (or Fossil Forced Air)	This ISU is displayed only if ISU 200 is set to heat pump AND if ISU 221 Aux/E heat stages = 1. Note: Options of this ISU may vary depending on the model of the thermostat.
256	EM Heat Type	<b>Electric</b> , Gas/Oil (or Fossil Forced Air)	This ISU is displayed only if ISU 200 is set to Heat Pump AND if ISU 221 Aux/E heat stages = 1 AND if ISU 253 is set to run Aux/E heat separately. Note: This ISU may not be available at all on some models.
260	Fossil Kit Control	<b>Thermostat</b> , External (Fossil Fuel Kit Controls Backup Heat)	This ISU is displayed only if ISU 200 is set to Heat Pump AND if ISU 221 Aux/E heat stages = 1, AND if ISU 256 is set to Gas/Oil. Note: This ISU is available on TH6320 model only.
300	Auto Changeover	On, <b>Off</b>	<b>OFF:</b> The user must select heating or cooling as needed to maintain the desired indoor temperature. <b>ON (Automatic):</b> On (enabled) Allows user to select Auto Changeover as one of the system modes from the home screen. In auto mode, the thermostat can control either heating or cooling to maintain the desired indoor temperature.
303	Auto Differential	<b>0 °F</b> to 5 °F or <b>0.0 °C</b> to 2.5 °C	Differential is the minimum number of degrees rise or fall required during off cycle to switch from the last active mode (heat or cool) to the opposite mode when the thermostat is in auto-changeover. Differential is NOT deadband. The deadband temperature between when heating (or cooling) cycles on and cycles off to maintain setpoint is not adjustable. The thermostat uses an algorithm that fixes deadband at 0 °F (0 °C).
305	High Cool Stage Finish	Yes, <b>No</b>	This ISU is only displayed when the thermostat is set to 2 cool stages. When set to YES, this feature keeps the higher stage of the cooling equipment running until the desired setpoint is reached.
306	High Heat Stage Finish	Yes, <b>No</b>	This ISU is only displayed when the thermostat is set to 2 or more heat stages. When set to YES, this feature keeps the higher stage of the heating equipment running until the desired setpoint is reached.
340	Aux Heat Droop	<b>0 = Comfort</b> ; 2 °F to 15 °F from setpoint (in 1 °F increments) or 1.0 °C to 7.5 °C from setpoint (in 0.5 °C increments)	Aux heat droop can be set on heat pump systems with an auxiliary heat stage. The Comfort setting is NOT available for Dual Fuel systems. Default setting is 0 °F (0 °C) (Comfort) for Electric while 2 °F (1.0 °C) for Gas/Oil. The indoor temperature must drop to the selected droop setting before the thermostat will turn Aux Heat on. For example, if Aux Heat is set to 2 °F (1.0 °C), the indoor temperature must be 2 °F (1.0 °C) away from the setpoint before Aux Heat turns on. When set to Comfort, the thermostat will use Aux Heat as needed to keep the indoor temperature within 1 °F (0.5 °C) degree of the setpoint.
350	Up Stage Timer Aux Heat	<b>Off</b> , 30, 45, 60, 75, 90 minutes 2, 3, 4, 5, 6, 8, 10, 12, 14, 16 hours	The Auxiliary Heat Upstage Timer starts when the highest stage of the previous heating equipment type turns on. Auxiliary heat will be used (if needed) when the timer expires. This ISU is only displayed when ISU 340 (Aux Heat Droop) is set to 2 °F (1.0 °C) or higher.

# Installer setup options (ISU)– advanced menu

**Table 3.**

# ISU	ISU Name	ISU Options (defaults in bold)	Notes
355	Balance Point (Compressor Lockout)	<b>Off</b> , 5 °F to 60 °F (in 5 °F increments) or -15.0 °C to 15.5 °C (in 2.5 °C or 3.0 °C increments)	Compressor Lockout requires an outdoor temperature. Set Compressor Lockout to the temperature below which it is inefficient to run the heat pump. When outside temperature is below this setting, thermostat will lockout heat pump and run Aux Heat only. This ISU is only displayed if ISU 130 = Wired or Internet, ISU 200 is set to Heat Pump, ISU 221 Aux/E stages = 1, AND ISU 260 is set to Thermostat. We recommend using a wired remote sensor as an outdoor temperature source. Default is 40 °F (4, 4 °C) if ISU 205 Heating Equipment is Air to Air Heat Pump and ISU 255 Aux Heat Type is Gas/Oil. Default is Off if ISU 205 Heating Equipment is Air to Air Heat Pump and ISU 255 Aux Heat Type is Electric. Default is Off if ISU 205 Heating Equipment is Geothermal. Compressor Lockout is optional for any type of heat pump (Air to Air Heat Pump, Geothermal Heat Pump).
356	Aux Heat Lock Out (Aux Heat Outdoor Lockout)	<b>Off</b> , 5 °F to 65 °F (in 5 °F increments) or -15.0 °C to 18.5 °C (in 2.5 °C or 3.0 °C increments)	Aux Heat Lockout requires an outdoor temperature. Set Aux Heat Lockout to optimize energy bills and to not allow it to run the more expensive Aux Heat source above certain outdoor temperature limit. This ISU is only displayed if ISU 200 is set to Heat Pump, AND ISU 260 is set to Thermostat control AND if ISU 221 Aux/E stages = 1.
365	Cool 1 CPH (Cooling cycle rate stage 1)	1 - 6 CPH ( <b>3 CPH</b> )	This ISU is only displayed when Cool/Compressor Stages is set to 1 or more stages. Cycle rate limits the maximum number of times the system can cycle in a 1 hour period measured at a 50% load. For example, when set to 3 CPH, at a 50% load, the most the system will cycle is 3 times per hour (10 minutes on, 10 minutes off). The system cycles less often when load conditions are less than or greater than a 50% load.
366	Cool 2 CPH (Cooling cycle rate stage 2)	1 - 6 CPH ( <b>3 CPH</b> )	This ISU is only displayed when Cool/Compressor Stages is set to 2.
370	Heat 1 CPH (Heating cycle rate stage 1)	1 - 12 CPH	This ISU is only displayed when Heat Stages is set to 1 stage or more stages. Cycle rate limits the maximum number of times the system can cycle in a 1 hour period measured at a 50% load. For example, when set to 3 CPH, at a 50% load, the most the system will cycle is 3 times per hour (10 minutes on, 10 minutes off). The system cycles less often when load conditions are less than or greater than a 50% load. The recommended (default) cycle rate settings are below for each heating equipment type: <b>Standard Efficiency Gas Forced Air = 5 CPH; High Efficiency Gas Forced Air = 3 CPH; Oil Forced Air = 5 CPH; Electric Forced Air = 9 CPH; Fan Coil = 3 CPH; Hot Water Radiant Heat = 3 CPH; Steam = 1 CPH.</b>
371	Heat 2 CPH (Heating cycle rate stage 2)	1 - 12 CPH	This ISU is only displayed when Heat Stages is set to 2 stages. The recommended (default) cycle rate settings are below for each heating equipment type: <b>Standard Efficiency Gas Forced Air = 5 CPH; High Efficiency Gas Forced Air = 3 CPH; Oil Forced Air = 5 CPH; Electric Forced Air = 9 CPH; Fan Coil = 3 CPH; Hot Water Radiant Heat = 3 CPH; Steam = 1 CPH.</b>
375	Aux Heat CPH (Heating cycle rate Auxiliary Heat)	1 - 12 CPH	This ISU is only displayed when ISU 200 = Heat Pump and ISU 221=1. It is only displayed when Auxiliary Heat is configured. The recommended cycle rate settings are below for each heating equipment type: <b>Standard Efficiency Gas Forced Air = 5 CPH; High Efficiency Gas Forced Air = 3 CPH; Oil Forced Air = 5 CPH; Electric Forced Air = 9 CPH.</b>

# Installer setup options (ISU) – advanced menu

**Table 4.**

# ISU	ISU Name	ISU Options (defaults in bold)	Notes
378	EM Heat CPH (Heating cycle rate Emergency Heat)	1 - 12 CPH	This ISU is only displayed when Emergency Heat is configured and ISU 253-Aux/E Terminal Control is set to control Aux and E heat independently. The recommended cycle rate settings are below for each heating equipment type: <b>Standard Efficiency Gas Forced Air = 5 CPH; High Efficiency Gas Forced Air = 3 CPH; Oil Forced Air = 5 CPH; Electric Forced Air = 9 CPH.</b>
387	Compressor Protection	<b>Off</b> , 1 - 5 minutes	The thermostat has a built in compressor protection (minimum off timer) that prevents the compressor from restarting too early after a shutdown. The minimum-off timer is activated after the compressor turns off. If there is a call during the minimum-off timer, the thermostat shows "Wait" in the display. This ISU is displayed if ISU 220 is set to at least 1 stage.
390	Ext Fan Run Time in Cool	<b>Off</b> : 30, 60, 90 seconds 2, 3, 4, 5, 6, 7, 8, 9, 10, 11, 12, 13, 14, 15 minutes	After the call for cooling ends, the thermostat keeps the fan on for the selected amount of time for increased efficiency. This may reintroduce humidity into the living space. This ISU is displayed if ISU 220 is set to at least 1 stage.
391	Ext Fan Run Time in Heat	<b>Off</b> : 30, 60, 90 seconds 2, 3, 4, 5, 6, 7, 8, 9, 10, 11, 12, 13, 14, 15 minutes	After the call for heating ends, the thermostat keeps the fan on for the selected amount of time for increased efficiency. This ISU is displayed if ISU 230 is set to Thermostat Controls Fan.
425	Adaptive Recovery	<b>On</b> , Off	Adaptive Intelligent Recovery (AIR) is a comfort setting. Heating or cooling equipment will turn on earlier, ensuring the indoor temperature will match the setpoint at the scheduled time.
429	Max Cool Temperature	from Min. Cool Temp. to 99 °F or to 37.0 °C (90 °F or 32 °C)	The user cannot set the cooling temperature above this level.
430	Min Cool Temperature	from 50 °F or 10.0 °C to Max. Cool Temp. (50 °F or 10 °C)	The user cannot set the cooling temperature below this level.
431	Max Heat Temperature	from Min. Heat Temp. to 90 °F or to 32.0 °C (90 °F or 32 °C)	The user cannot set the heating temperature above this level.
432	Min Heat Temperature	from 40 °F or 4.4 °C to Max. Heat Temp. (50 °F or 10 °C)	The user cannot set the heating temperature below this level.
500	Indoor Sensor	Yes, <b>No</b>	Set this ISU when you want to wire a remote indoor sensor to the "S" terminals on the UWP - see "Wiring" on page 5. This ISU is only displayed only if ISU 130 is set to NO wired outdoor sensor configured
515	Sensor type	<b>10k</b> , 20k	Choose resistance type of wired indoor sensor. This ISU is only displayed when indoor sensor is configured - ISU 500.
520	Temperature Control	Thermostat, Wired, <b>Average</b>	This ISU is only displayed when indoor sensor is configured - ISU 500. You can choose what temperature source to be used or you can ask thermostat to use both thermostat and remote sensors for higher accuracy of measurement.
702	Air Filters	<b>0 - 2</b>	This ISU refers to the number of air filters in the system.
711	Air Filter 1 Reminder	<b>Off</b> 10, 20, 30, 45, 60, 90, 120, 150 Run Time Days 30, 45, 60, 75 Days 3, 4, 5, 6, 9, 12, 15 Months	Choose either calendar or equipment run time-based reminder.
712	Air Filter 2 Reminder	<b>Off</b> 10, 20, 30, 45, 60, 90, 120, 150 Run Time Days 30, 45, 60, 75 Days 3, 4, 5, 6, 9, 12, 15 Months	Choose either calendar or equipment run time-based reminder.

# Installer setup options (ISU)– advanced menu

**Table 5.**

# ISU	ISU Name	ISU Options (defaults in bold)	Notes
810	Hum Pad Reminder	<b>Off</b> 6, 12 Calendar Months	
921	Dehum Filter Reminder	<b>Off</b> 30, 60 Calendar Days 3 - 12 Calendar Months (in 1 month increments)	
1000	Vent Type	<b>None</b> , ERV/HRV, Passive, Fresh Air Damper	<b>None:</b> The thermostat does not control ventilation. <b>ERV/HRV:</b> The thermostat controls an Energy Recovery Ventilator or Heat Recovery Ventilator for ventilation. <b>Passive (Fan Only):</b> The thermostat turns on the fan for ventilation. When set to passive fan, the thermostat does not control a damper or ventilator. The passive ventilation/passive fan setting only runs the indoor blower fan. This setting does not open a damper or run a ventilator. To use this setting for ventilation, the home would need to be set-up with a pipe from outdoors into the return duct that is either permanently open or has a damper that automatically opens whenever the blower fan is on. Note: Some models only offer the passive fan setting.
1005	Vent Method	ASHRAE 2010, <b>ASHRAE 2013</b> , Percent On Time	Note: Options of this ISU may vary depending on the model of the thermostat.
1006	Vent Fan Control	<b>Thermostat</b> , Equipment	<b>Thermostat:</b> The thermostat turns on the ventilation and the fan when ventilation is needed. <b>Equipment:</b> Ventilation equipment controls the blower fan.
1007	Bedrooms	1 - 6 ( <b>2</b> )	This ISU is only displayed when ISU 1005 Ventilation Method is set to ASHRAE 2010 or 2013.
1008	Home Size	1000 Sq. Ft. - 5000 Sq. Ft. ( <b>1000 Sq. Ft.</b> )	This ISU is only displayed when ISU 1005 Ventilation Method is set to ASHRAE 2010 or 2013.
1009	Vent Rate	30CFM - 350CFM (in 5CFM increments) ( <b>150CFM</b> )	This ISU is only displayed when ISU 1005 Ventilation Method is set to ASHRAE 2010 or 2013.
1011	Vent Percent On Time	10% - 100% ( <b>30%</b> )	The thermostat operates ventilation equipment based on a percentage entered in the installer setup (ISU 1012). For example, if Percent on Time is set to 50%, the ventilation equipment will run at random times during a 1 hour period until it reaches a 50% run time (approximately 30 minutes). This ISU is only displayed if ISU 1005 is set to Percent On Time.
1012	Vent Priority	<b>Lockouts</b> , ASHRAE	<b>Lockouts are Priority:</b> The thermostat places a priority on lockouts versus the ASHRAE ventilation standard. The thermostat will not run ventilation during the following lockout conditions (if configured), unless you manually call for ventilation: Lockout: Ventilation during "Outdoor Conditions" (ISU 1013, 1014 and 1015). Lockout: Ventilation during "Sleep" program periods. Note: This option is set by the user on the Ventilation screen in the Menu. <b>ASHRAE is Priority:</b> ASHRAE requires additional ventilation following a long off cycle. The thermostat meets the ASHRAE ventilation standard by running additional ventilation when outdoor conditions are favorable. If ASHRAE cannot be met when outdoor conditions are favorable, the thermostat will override the outdoor lockouts and run ventilation. When using this option, it is recommended that you increase the rate (CFM) of the ventilation equipment to meet the ASHRAE ventilation standard in a shorter run time. The ability to lockout ventilation during the "Sleep" is not an option when you select ASHRAE is Priority.

# Installer setup options (ISU) – advanced menu









**Table 6.**

# ISU	ISU Name	ISU Options (defaults in bold)	Notes
1013	Low Outdoor Temp Vent Lockout	<b>Off</b> , -20 °F to -40 °F (in 5 °F increments) or -28.0 °C to -4.0 °C (in 2.0 °C increments)	ISU 130 must be set to Wired or Internet. This ISU is only displayed when ISU 1000 Ventilation Type is set to ERV / HRV or Fresh Air Damper.
1014	High Outdoor Temp Vent Lockout	<b>Off</b> , 80 °F to 110 °F (in 5 °F increments) or 26 °C to 44 °C (in 2 °C increments)	ISU 130 must be set to Wired or Internet. This ISU is only displayed when ISU 1000 Ventilation Type is set to ERV / HRV or Fresh Air Damper.
1015	High Outdoor Dewpoint Vent Lockout	<b>Off</b> , 65 °F to 85 °F (in 5 °F increments) or 18 °C to 30 °C (in 2 °C increments)	ISU 130 must be set to Internet. This ISU is only displayed if ISU 1000 Ventilation Type is set to ERV/ HRV or Fresh Air Damper.
1017	Vent Core Reminder	<b>Off</b> , 3, 6, 9, 12 months	This ISU is displayed only if ISU 1000 is set to ERV/HRV.
1018	Vent Filter Reminder	<b>Off</b> , 3, 6, 9, 12 months	
1100	UV Devices	<b>0 - 2</b>	Some systems may have two UV devices, one for the A-Coil and another for Air Treatment. A replacement reminder can be setup for each one separately.
1105	UV Bulb 1 Reminder	<b>Off</b> , 6, 12, 24 months	
1106	UV Bulb 2 Reminder	<b>Off</b> , 6, 12, 24 months	
1401	Idle Brightness	<b>0 = Off</b> , 0 - 5	Adjust brightness of an inactive backlight (idle screen) from default 0 (backlight off) to 5 (maximum brightness).
1410	Clock Format	<b>12 hour</b> , 24 hour	
1415	Daylight Saving	<b>On</b> , <b>Off</b>	Set to Off in areas that do not follow Daylight Saving Time.
1420	Temp Offset	<b>Off</b> , -3 °F to 3 °F (in 1 °F increments) or -1.5 °C to 1.5 °C (in 0.5 °C increments)	0 °F (0 °C) - No difference in displayed temperature and the actual room temperature. The thermostat can display up to 3 °F (1.5 °C) lower or higher than the actual measured temperature.



# Performing a system test

You can test the system setup in **ADVANCED MENU** under **SYSTEM TEST** option.



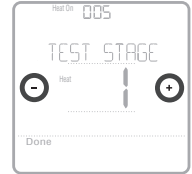
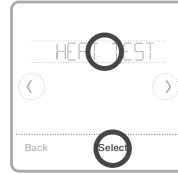
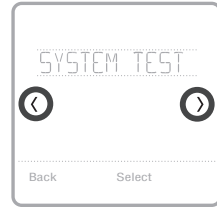

- 1 Press and hold **Menu** on the thermostat for 5 seconds to access **ADVANCED MENU** options.
- 2 Touch  or  to go to **SYSTEM TEST**.
- 3 Touch **Select** or touch text area.
- 4 Touch  or  to select system test type. Touch **Select** or touch text area.
- 5 For the heat test and cool test, use  or  to activate each stage of the equipment. For the fan test, use  or  to turn the fan on and off.

**NOTE:** The clock is used as a timer while the stages are running. The Heat On and Cool On indicators are displayed when the system test is running.



# Viewing equipment status

You can see the status of thermostat-controlled equipment in the **Menu** under the **EQMT STATUS** option.

- 1 Touch **Menu** on your thermostat.
- 2 Touch  or  to go to **EQMT STATUS**. Touch **Select** or touch text area.
- 3 Touch  or  to view statuses of all the equipment the thermostat is controlling. Depending on what feature the thermostat supports or how it was installed, the Equipment Status screen reports data for the following systems:

- Heating and cooling
- Fan
- Ventilation (available on certain models only)

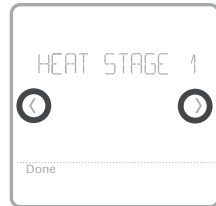
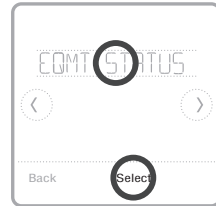

# Troubleshooting

- Screen is blank**
- Check circuit breaker and reset if necessary.
  - Make sure power switch at heating and cooling system is on.
  - Make sure furnace door is closed securely.
- Screen is difficult to read**
- Change screen brightness in thermostat **Menu**. Increase brightness intensity for inactive backlight of the thermostat screen (max. is level 5).
- Heating or cooling system does not respond**
- Touch **Mode** to set system to Heat. Make sure the temperature is set higher than the Inside temperature.
  - Touch **Mode** to set system to Cool. Make sure the temperature is set lower than the Inside temperature.
  - Check circuit breaker and reset if necessary.
  - Make sure power switch at heating & cooling system is on.
  - Make sure furnace door is closed securely.
- Heat runs with cooling**
- Verify there is not a wire attached to W for heat pump systems. See wiring on pages 5-6.

## Alerts and reminders

Alerts and reminders are displayed via the alert symbol and alert number in the clock area on the home screen. You can read more information about active alerts, snooze or dismiss non-critical alerts in Menu/Alerts.

Number	Alert/Reminder	Definition
164	Heat Pump Needs Service	Heat pump needs service. Contact dealer to diagnose and service heat pump.
168	Wi-Fi Radio Error	Wireless features are not available. Try removing the thermostat from the wallplate or power cycle at breaker for 1 minute. If the code is still shown, please contact dealer to replace the thermostat.
170	Internal Memory Error	The memory of the thermostat has encountered an error. Please contact dealer for assistance.
171	Set the Date and Time	Set the date and time on your thermostat. The date and time are required for certain features to operate, like the program schedule.
173	Thermostat Temperature Sensor Error	The sensor of the thermostat has encountered an error. Please contact dealer to replace the Thermostat.
175	AC Power Resumed	AC power resumed to thermostat after power loss.
177	Indoor Temperature Sensor Error	Wired indoor temperature sensor is not connected or there is a wiring short. Please contact dealer for assistance.
178	Outdoor Temperature Sensor Error	Wired outdoor temperature sensor is not connected or there is a wiring short. Please contact dealer for assistance.

## Alerts and reminders

Number	Alert/Reminder	Definition
181	Replace Air Filter (1)	Replace air filter (1). Reset the timer by touching the "dismiss" button on thermostat screen after it is replaced.
182	Replace Air Filter (2)	Replace air filter (2). Reset the timer by touching the "dismiss" button on thermostat screen after it is replaced.
183	Clean Humidifier Tank and Replace Water Filter	Clean humidifier tank and replace the water filter, or contact dealer to do this for you. Reset the timer by touching the "dismiss" button on the thermostat screen after it is replaced.
184	Replace Humidifier Pad	Replace humidifier pad. Reset the timer by touching the "dismiss" button on the thermostat screen after it is replaced.
185	Replace Dehumidifier Filter	Replace the dehumidifier filter. Reset the timer by touching "dismiss" button on thermostat screen after it is replaced.
186	Clean Ventilator Core	Clean ventilator core. Reset the timer by touching the "dismiss" button on thermostat screen after it is replaced.
187	Clean or Replace Ventilator Filter	Clean or replace ventilator filter. Reset the timer by touching the "dismiss" button on thermostat screen after it is replaced.
188	Replace UV Bulb (1)	Replace UV Bulb (1). Reset the timer by touching the "dismiss" button on thermostat screen after it is replaced.
189	Replace UV Bulb (2)	Replace UV Bulb (2). Reset the timer by touching the "dismiss" button on thermostat screen after it is replaced.
210	Register Online For Outdoor Temperature	Online registration is required to receive outdoor temperature from the Internet. Outdoor temperature is needed for your current system setup. Download the Honeywell Home app to register your thermostat.
388	Register Online for Remote Access and Outdoor Temperature	Online registration is required for remote access and outdoor temperature. Download the Honeywell Home app to register your thermostat.
399	No Internet	The connection to the Internet has been lost. Please check your network settings.
400	No Wi-Fi Signal	The Wi-Fi signal has been lost. Please wait for the thermostat to reconnect or select a new Wi-Fi network. Follow steps in the Honeywell Home app
508	Wi-Fi Not Configured	Please download the Honeywell Home app and follow the steps to connect thermostat to your Wi-Fi network.

**CAUTION: ELECTRICAL HAZARD**

Can cause electrical shock or equipment damage. Disconnect power before beginning installation.

**CAUTION: EQUIPMENT DAMAGE HAZARD**

Compressor protection is bypassed during testing. To prevent equipment damage, avoid cycling the compressor quickly.

**CAUTION: MERCURY NOTICE**

If this product is replacing a control that contains mercury in a sealed tube, do not place the old control in the trash. Contact your local waste management authority for instructions regarding recycling and proper disposal.

## Specifications

**Temperature Ranges**

Heat: 40 °F to 90 °F (4.5 °C to 32.0 °C)  
Cool: 50 °F to 99 °F (10.0 °C to 37.0 °C)

**Operating Ambient Temperature**

37 °F to 102 °F (2.8 °C to 38.9 °C)

**Shipping Temperature**

-20 °F to 120 °F (-28.9 °C to 48.9 °C)

**Operating Relative Humidity**

5% to 90% (non-condensing)

**Physical Dimensions in inches (mm) (H x W x D)**

T6 Pro Smart Thermostat (TH6320WF2003):

4-5/64 x 4-5/64 x 1-1/16 (104 x 104 x 27)

T6 Pro Smart Thermostat (TH6220WF2006):

4-5/64 x 4-5/64 x 1-1/16 (104 x 104 x 27)

**Electrical Ratings**

Terminal	Voltage (50Hz/60Hz)	Running Current
W Heating (Powerpile)	20 Vac-30 Vac 750 mV DC	0.02 A-1.0 A 100 mA DC
W2 (Aux) Heating	20 Vac-30 Vac	0.02 A-1.0 A
E Emergency Heat	20 Vac-30 Vac	0.02 A-0.5 A
Y Compressor Stage 1	20 Vac-30 Vac	0.02 A-1.0 A
Y2 Compressor Stage 2	20 Vac-30 Vac	0.02 A-1.0 A
G Fan	20 Vac-30 Vac	0.02 A-0.5 A
O/B Changeover	20 Vac-30 Vac	0.02 A-0.5 A
L/A Input	20 Vac-30 Vac	0.02 A-0.5 A
U	20 Vac-30 Vac	0.02 A-0.5 A

## 5-year limited warranty

For Warranty information go to  
<http://customer.resideo.com>

**Power Consumption**

Backlight On: 1.48VA

Backlight Off: 0.88VA

## Regulatory information

**FCC REGULATIONS****47 CFR § 15.19 (a)(3)**

This device complies with part 15 of the FCC Rules. Operation is subject to the following two conditions:

1. This device may not cause harmful interference, and
2. This device must accept any interference received, including interference that may cause undesired operation.

**47 CFR § 15.21 (USA only)**

Changes or modifications not expressly approved by the party responsible for compliance could void the user's authority to operate the equipment.

**47 CFR § 15.105 (b)**

See <https://customer.resideo.com/en-US/support/residential/codes-and-standards/FCC15105/Pages/default.aspx> for additional FCC information for this product.

**IC REGULATIONS****RSS-GEN**

This device contains licence-exempt transmitter(s)/receiver(s) that comply with Innovation, Science and Economic Development Canada's licence-exempt RSS(s). Operation is subject to the following two conditions:

1. This device may not cause interference.
2. This device must accept any interference, including interference that may cause undesired operation of the device.

The operation of this equipment is subject to the following two conditions:

- (1) This equipment or device may not cause harmful interference, and (2) this equipment or device must accept any interference, including interference that may cause undesired operation.



Resideo Technologies, Inc.  
1985 Douglas Drive North, Golden Valley, MN 55422  
1-800-633-3991  
33-00392-09 M.S. Rev. 04-20 | Printed in United States

Wi-Fi® is a registered trademark of  
Wi-Fi Alliance®