

Install guide 6035

ritētemp[®]

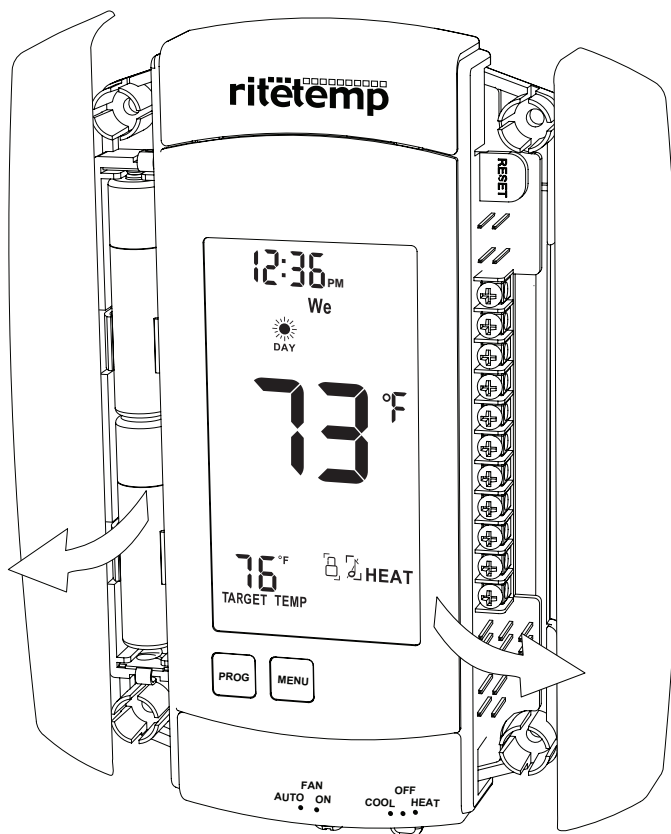

Caution

- Your thermostat is a precise instrument, handle it with care.
- Turn off electricity to the appliance before installing or servicing thermostat or any part of the system.
- Do not turn electricity back on until work is completed.
- Do not short (jumper) across electric terminals at control on furnace or air conditioner to test the system. This will damage the thermostat and void your warranty.
- All wiring must conform to local codes and ordinances.
- This thermostat is designed for use with 24 volt AC and millivolt systems. The thermostat should be limited to a maximum of 1.0 amps; higher amperage may cause damage to the thermostat.

ENGLISH

Install guide 6035



Caution

To avoid electrical shock and to prevent damage to the furnace, air conditioner, and thermostat, disconnect the power supply before beginning work. This can be done at the circuit breaker, or at the appliance.

Tools

You will need a small Phillips screwdriver and possibly a drill with 3/16-in. (4.8mm) bit for wall mounting.

Location

Replacement installations - mount the new thermostat in place of the old one.

New installations - follow the guidelines listed below.

- Locate the thermostat on an inside wall, about 5 ft. (1.5m) above the floor, and in a room that is used often.

PG 1

- Do not install it where there are unusual heating conditions, such as: in direct sunlight; near a lamp, radio, television, radiator register, or fireplace; near hot water pipes in a wall; near a stove on the other side of a wall.

- Do not locate in unusual cooling conditions, such as: on a wall separating an unheated room; or in a draft from a stairwell, door, or window.

- Do not locate in a damp area. This can lead to corrosion that will shorten thermostat life.

- Do not locate where air circulation is poor, such as: in a corner or an alcove; or behind an open door.

- Do not install the unit until all construction work and painting has been completed.

- This thermostat does not require leveling.

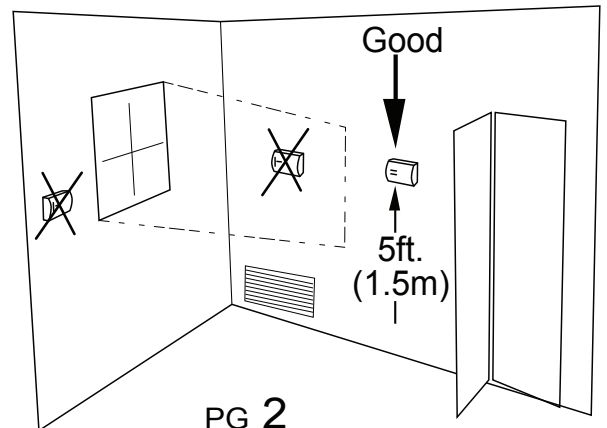

PG 2

Remove old unit

- Switch electricity to the furnace and air conditioner **OFF**; then proceed with the following steps.

- Remove cover from old thermostat. Most are snap-on types and simply pull off. Some have locking screws on the side or front. These must be loosened. Note the letters printed near the terminals. **Attach labels** (enclosed) to each wire for identification.

IMPORTANT : LABEL ALL WIRES BEFORE DISCONNECTING THEM!

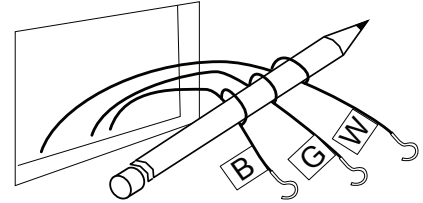

Caution

Read instructions carefully before removing any wiring from existing thermostat. Wires must be labeled before they are removed. **THERE IS NO STANDARD COLOR CODE.** When removing wires from their terminals, ignore the color of the wires since these may not comply with any standard.

PG 3

- Label the wires one at a time. You must label all the wires **before you proceed**. **With all wires labeled**, remove them from the old unit.
- Make sure the wires do not fall back inside the wall. You can wind them around a pencil to keep them from falling.
- Loosen all screws on the old thermostat and remove it from the wall.
- Fill wall opening with non-combustible insulation to prevent drafts.

Prepare wires

- You will need at least 2.6" of wire for each of your connections to the 6035.
- If you do not have enough wire, splice additional wire to allow enough slack.
- Fan out wires below the hole as shown.

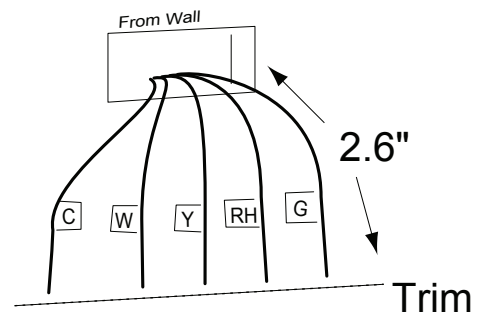

PG 4

Before you Connect Wires

Please follow these guidelines for safe and secure wire connections.

- Easy Terminals do not require stripping the wire.
- Clip any bare wire from previous installation.
- Take care not to damage the labels for each wire in handling.
- Fan wires out as illustrated with 6035 below the wall opening.
- Wires will dress behind the 6035 and up over the terminal area.
- Use the Step-By-Step diagram as your guide.
- Do not bunch wires behind 6035. Feed slack back into the wall opening.
- Connect labeled wires only to a terminal with corresponding letter.

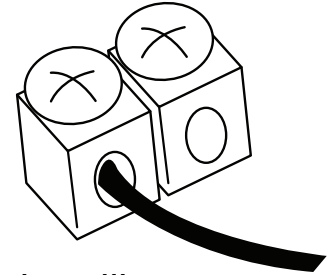

Caution

Do not allow wires to touch each other or parts on thermostat.

- Insert the wire in the terminal and tighten the screw securely.
- You will need to set Configuration Jumpers per the Step-By-Step diagram. A needle-nose plier may be needed to modify jumper locations.

What wires do you have?

Determine which step-by-step wiring diagram below you should use. Make sure your wires are labeled. This may require you to find the 'other end' connection for each wire on your heating or air conditioning equipment and read the label there.

If you have a wire marked "C" it is optional. If you do connect it, the thermostat will draw power from the C wire. This extends battery life.

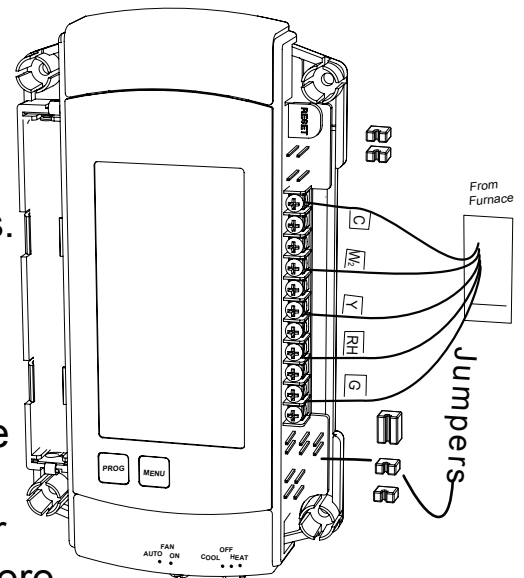

Find the set-up diagram for your system

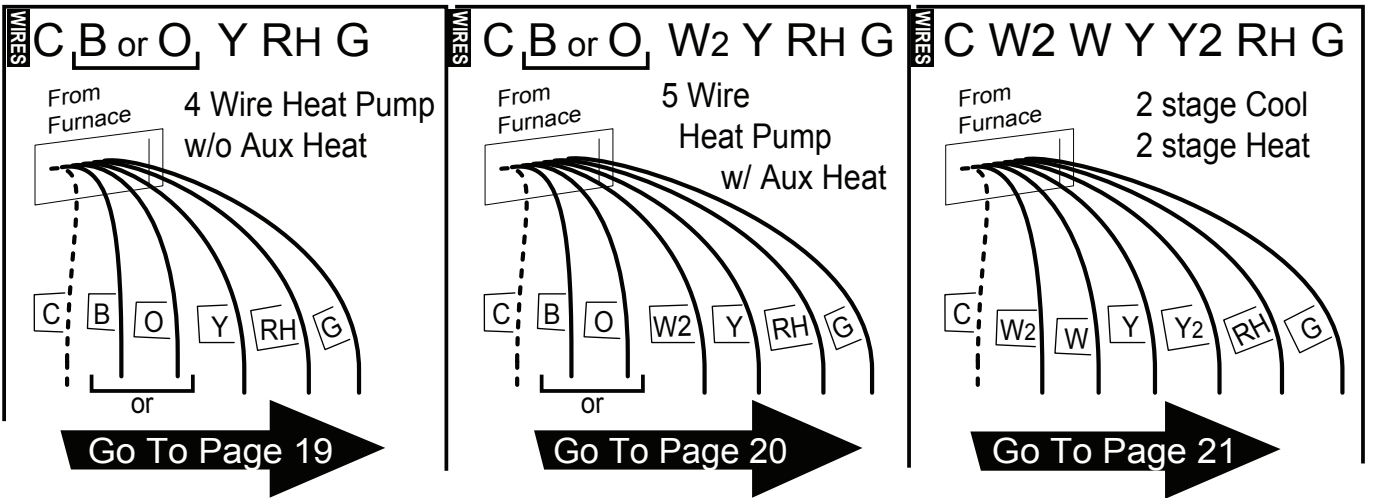
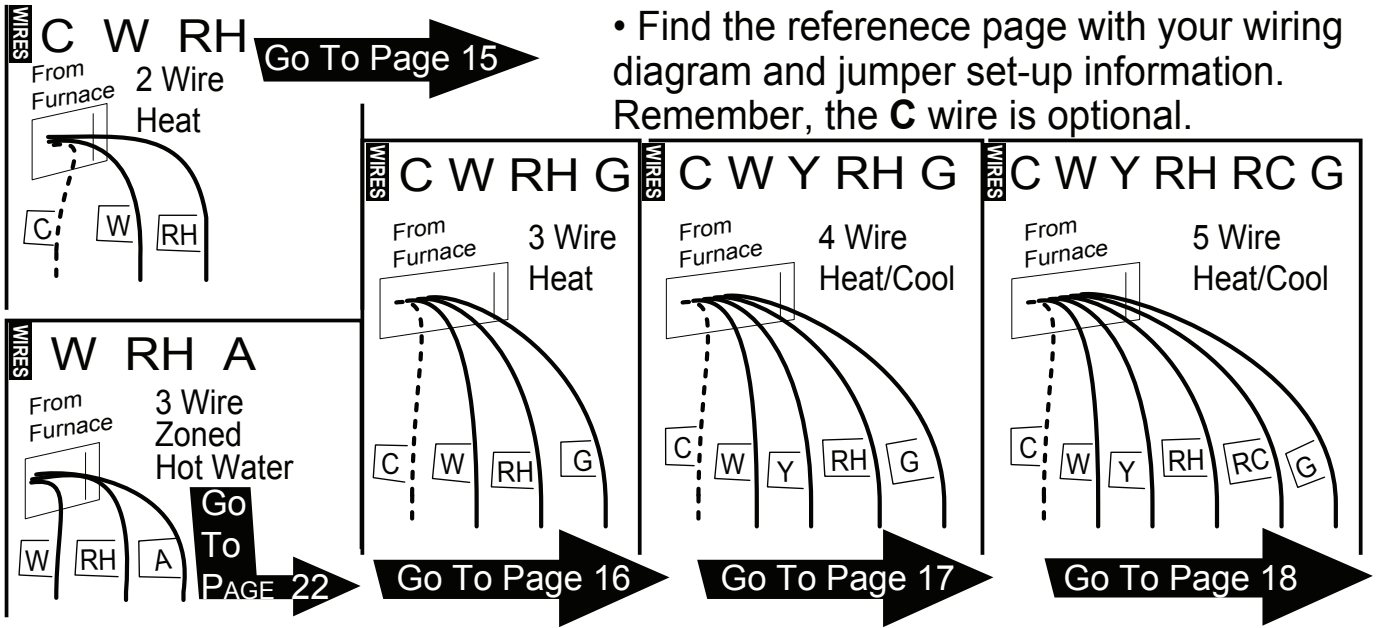

• If your combination of wires is not above you can use the wiring table on pages 24-25 to determine your connections, or call our USA support line at 1-877-505-2353 for help.

Mount the 6035

- Hold the 6035 against the wall, with the wires coming around the side by terminal block. The 6035 will cover the hole in the wall.
- Position 6035 for best appearance. Use the optional stand- offs if more space for wires is

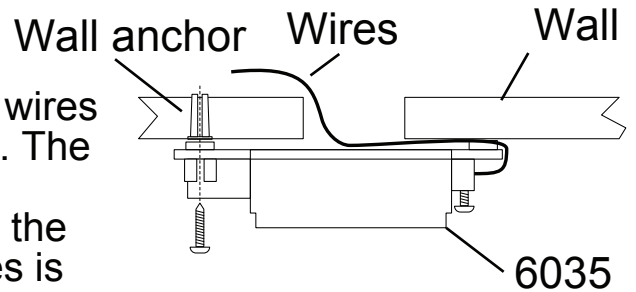
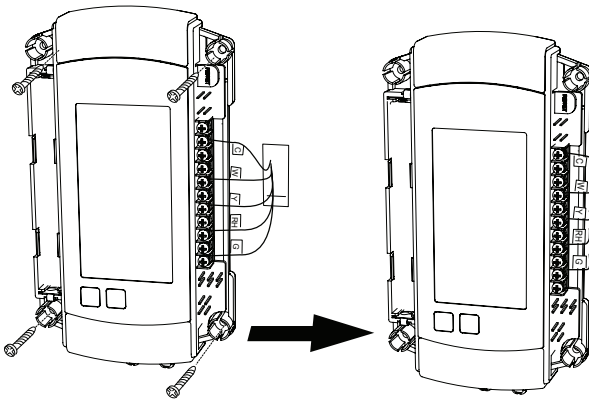

needed behind the 6035.

- Attach the base to the wall with the screws provided.
- If you are mounting the base to sheet rock or if you are using the old mounting holes, use the plastic anchors provided. Drill a 3/16-in.(4.8mm) hole for the insert at each screw location, then mount the base.

PG 9

Install AAA Batteries

- The 6035 requires 2 AAA batteries to operate .
- Switch MODE switch to OFF and the FAN switch to AUTO.
- Install 2 AAA alkaline batteries according to the polarity noted in the compartment. LCD segments will go on.
- Press the **RESET** button (under right cover) to clear transient program memory. NOTE: Replace the batteries when this LOW battery indicator appears on the display or once a year.
- Replace covers on unit.

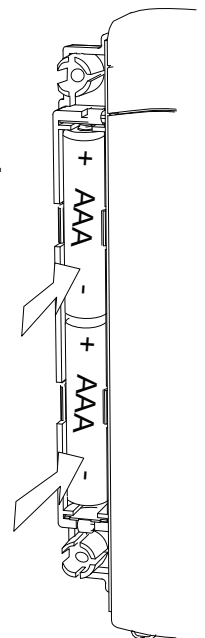

PG 10

Check Unit

Follow these procedures to verify you have correctly installed the 6035.

To check Fan: (If you connected the G wire - fan relay)

- Switch the FAN switch to the ON position. Verify that air is blowing from the system. Return to AUTO position for normal operation.

To check HEAT mode:

- Set the mode switch to HEAT.
- Set the fan switch to **AUTO**.
- Touch the room temperature and the heat target temperature will be displayed. Use the UP arrow to raise the target temp to 90F. Allow the system 2

minutes to respond then verify that heat is blowing from the system.

To check COOL mode:

- Set the mode switch to COOL.
- Touch the room temperature and the cool target temperature will be displayed. Use the DOWN arrow to lower the target temperature to 50F. Allow the system 2 minutes to respond
- Verify that cool air is blowing from the system.

Congratulations, you have successfully installed your unit. Please proceed to the OPERATING Guide to initialize the 6035.

NOTE: If you have labeled your wires, follow the correct Step-By-Step, and these Check procedures do not operate your system call support at 1-877-505-2353

Touch
Temperature
Display

PG 11

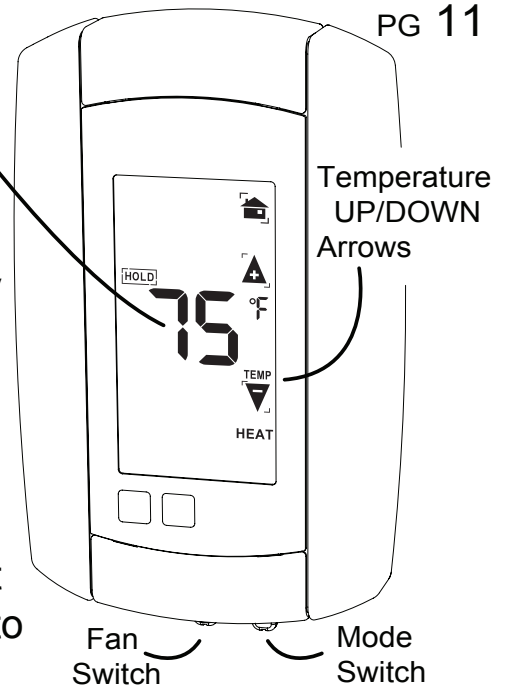

PG 12

Power Options

BATTERIES ONLY - This thermostat can run on batteries only using 2AAA alkaline batteries. The batteries will last at least 1 year; replace the batteries once a year or when the low battery icon comes on the display. If the batteries are not replaced, the thermostat will shut off the HVAC and then stop working.

24VAC - This thermostat can run on the HVAC 24VAC (C wire) if available. As shown in the wiring diagrams, the C wire is the other side of the 24VAC heating transformer and can be found where the other thermostat wires connect at the wall or at the furnace. Do not use the common or ground side of the line voltage. If the C wire is used, the batteries are then for back-up in case of power loss only and will last much longer. With the C wire connected, the thermostat will continue to work if the batteries die or are removed.

Calibration

NOTE: Your thermostat comes from the factory calibrated to $\pm 1^{\circ}$ of actual temperature. It is an accurate instrument. If you want your thermostat to display the same temperature as another thermometer in your home, you can adjust its calibration.

To change the calibration:

Push the MENU button; the present room temperature is displayed. To change it, use the up/down arrows and change the displayed room temperature as you wish $\pm 6^{\circ}\text{F}$. Your change will also be displayed on the lower left as the DELTA T factor or number of degrees changed. Push HOME icon or wait 60 seconds. The new room temperature will now be displayed on the HOME screen.

Calibrate controls

Calibrate factor

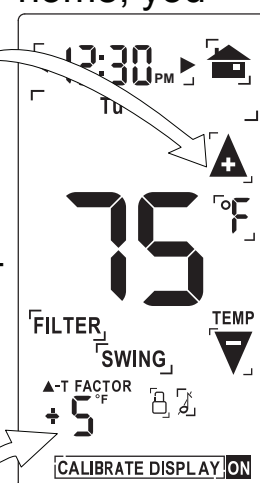

STEP 1 - Connect the **R** (or RH) wire to the **RH** terminal on the 6035. This connects the Heater Power to the thermostat.

SET JUMPERS

STEP 2 - Connect the **W** wire to the **W** on the 6035.

This connects the heater control line to the 6035.

STEP 3 - Set Config jumpers per this diagram.

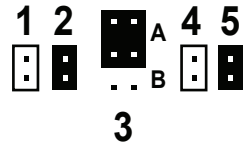

Your Heater is now connected to the 6035.

Please Go To Page 9



NOTE: Wires marked with dotted line are optional.

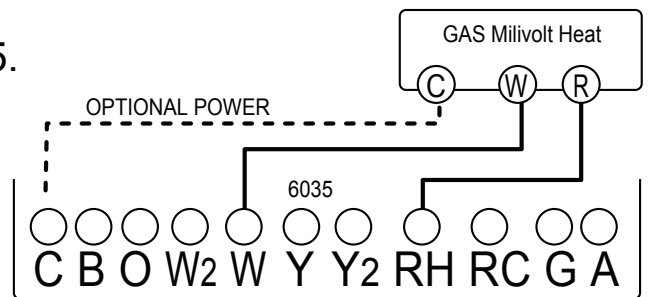

STEP 1 - Connect the **R** (or RH) wire to the **RH** terminal on the 6035. This connects to the Heater Power .

STEP 2 - Connect the **W** wire to the **W** terminal on the 6035. This connects the heater control line to the 6035.

STEP 3 - Connect the **G** wire to the **G** terminal on the thermostat. This connects the Fan to the 6035

STEP 4 - Set Config jumpers per this diagram. If you have Electric heat set 4, if you have Gas or Oil set 5.

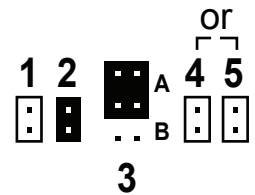

SET JUMPERS

Your system is now connected to the 6035.

Please Go To Page 9

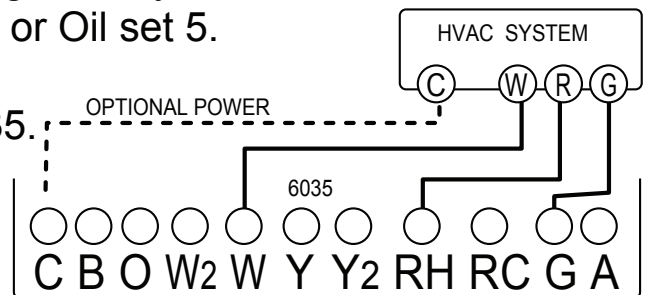

W Y R H G

4 Wire Heat/Cool

STEP 1 - Connect the **W** wire to the **W** terminal on the thermostat. This connects to the heater control line.

STEP 2 - Connect the **Y** wire to the **Y** terminal on the 6035. This connects to the Cooler compressor.

STEP 3 - Connect the **RH** or **R** wire to the **RH** terminal on the thermostat. This connects the Heater/Cooler Power.

STEP 4 - Connect the **G** wire to the **G** terminal on the Thermostat. This connects to the Fan.

STEP 5 - Set Config jumpers per this diagram. If you have Electric heat set 4, if you have Gas or Oil set 5.

Your HVAC system is now connected to the 6035.

← **Please Go To Page 9**

SET JUMPERS

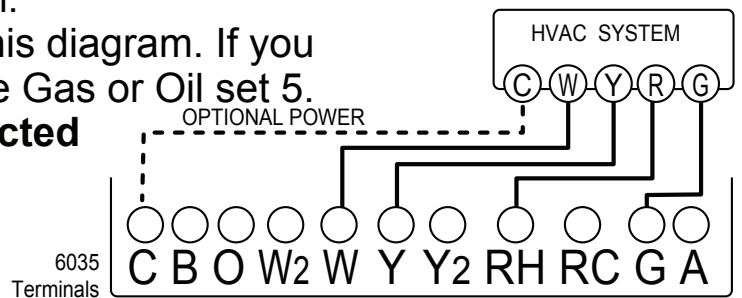
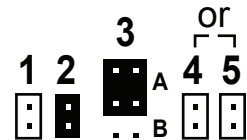

W Y R H R C G

5 Wire Heat/Cool

STEP 1 - Connect the **W** wire to the **W** terminal on the thermostat. This connects to the heater control line.

STEP 2 - Connect the **Y** wire to the **Y** terminal on the 6035. This connects to the Cooler compressor.

STEP 3 - Connect the **RH** wire to the **RH** terminal and the **RC** wire to the **RC** terminal on the 6035. This connects the Heater and Cooler Power.

STEP 4 - Connect the **G** wire to the **G** terminal on the Thermostat. This connects to the Fan.

STEP 5 - Set Config jumpers per this diagram. If you have Electric heat set 4, if you have Gas or Oil set 5.

Your HVAC system is now connected to the 6035.

← **Please Go To Page 9**

SET JUMPERS

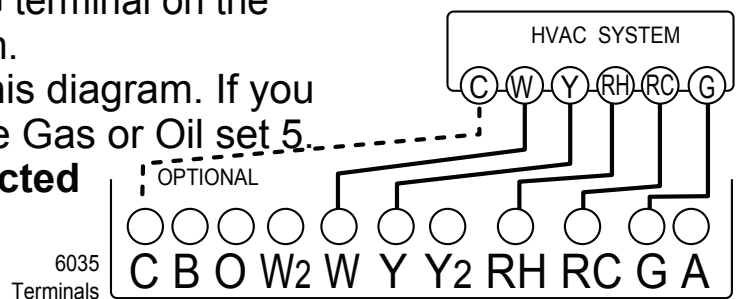
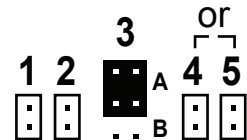

WIRE C B or O Y R G

4 Wire Heat Pump w/o Aux

STEP 1 - Connect **O** wire to the **O** terminal or **B** wire to the **B** terminal on the 6035. (If you have *both* **O** and **B** - connect **O** wire to **O** terminal DO NOT connect **B** to **B** terminal - see pg 24 Trane for **B** wire terminal) This connects the change-over valve.

STEP 2 - Connect the **Y** wire to **Y** on the 6035. This connects the Compressor.

STEP 3 - Connect the **R** wire to **RH** on the 6035. This connects to the 24vac power.

STEP 4 - Connect the **G** wire to the **G** terminal on the 6035. This connects the Fan.

STEP 5 - Set Config jumpers per this diagram.

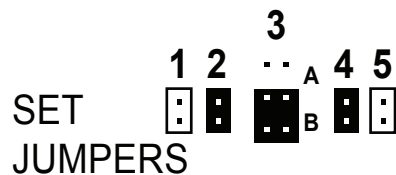

Your HVAC system is now connected to the 6035.

← Please Go To Page 9

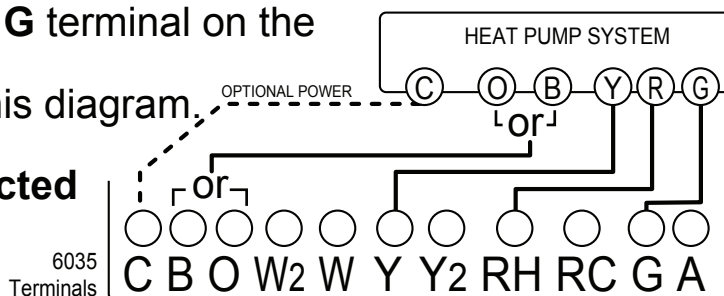

WIRE C B or O W2 Y RH G

5 Wire Heat Pump w/ Aux Heat

STEP 1 - Connect **O** wire to the **O** terminal or **B** wire to the **B** terminal on the 6035. (If you have *both* **O** and **B** -connect **O** wire to **O** terminal DO NOT connect **B** to **B** terminal - see pg 24 Trane for **B** wire terminal)

STEP 2 - Connect the **W2** wire to **W2** on the 6035.

STEP 3 - Connect the **Y** wire to **Y** on the 6035.

STEP 4 - Connect the **R** wire to **RH** on the 6035.

STEP 5 - Connect the **G** wire to **G** on the 6035.

STEP 6 - Set Config jumpers per this diagram. Set jumper 1 if you have Gas or Oil aux heat.

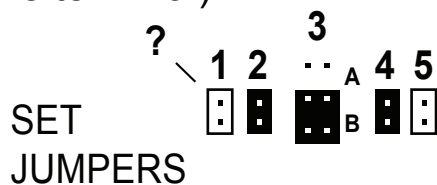

Your HVAC system is now connected to the 6035.

← Please Go To Page 9

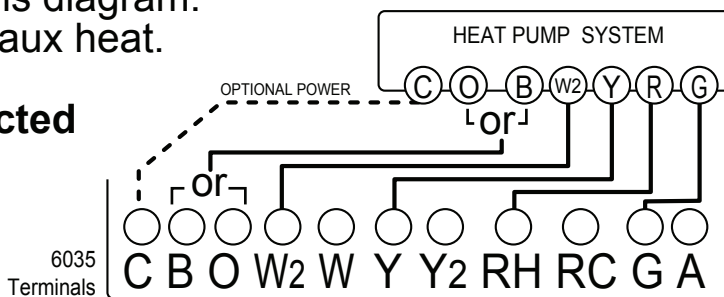

WIRES C W2 W Y Y2 RH G

2 Stage Heat and Cool

STEP 1 - Connect the **W** wire to the **W** terminal and **W2** to W2 on the 6035. This connects 2 stages of heat.

STEP 2 - Connect the **Y** wire to the **Y** terminal and Y2 wire to Y2 on the 6035. This connects 2 stages of cool.

STEP 3 - Connect the **RH** or **R** wire to the **RH** terminal on the thermostat. This connects the Heater/Cooler Power.

STEP 4 - Connect the **G** wire to the **G** terminal on the Thermostat. This connects to the Fan.

STEP 5 - Set Config jumpers per this diagram. If you have Electric heat set 4, if you have Gas or Oil set 5.

Your HVAC system is now connected to the 6035.

SET JUMPERS

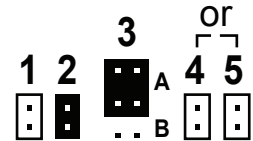

← Please Go To Page 9

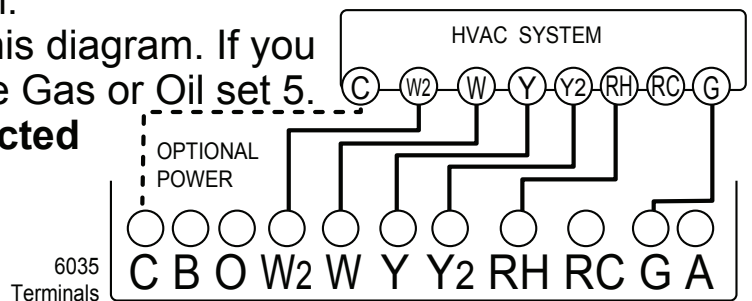

WIRES W RH [A?]

3 Zoned Hot Water - Motor Valve

Step 1 - based on your valve type

Motor driven Valve- Connect the **R** (or RH) wire to the **RH** terminal on the 6035. Connect the **W** wire to the **W** terminal on the 6035. Connect the **remaining** wire to the **A** terminal.

Solenoid valve -Connect the **R** (or RH) wire to the **RH** terminal on the 6035. Connect the **W** wire to the **A** terminal on the 6035. Connect the **remaining** wire to the **W** terminal.

STEP 2 - Set Config jumpers per this diagram.

SET JUMPERS

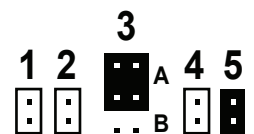

Your system is now connected to the 6035.

← Please Go To Page 9

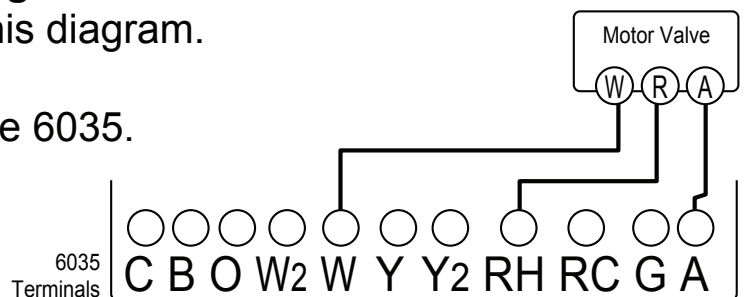

6035 Features

PG 23

This thermostat can be used with all millivolt and 24VAC heating and cooling systems. It cannot be used with line voltage systems. This thermostat is digital and your desired heat or cool temperatures can be easily be set on the large touch screen with the UP/DOWN arrows. A minimum 4 minute off time protects heating and cooling systems from damage.

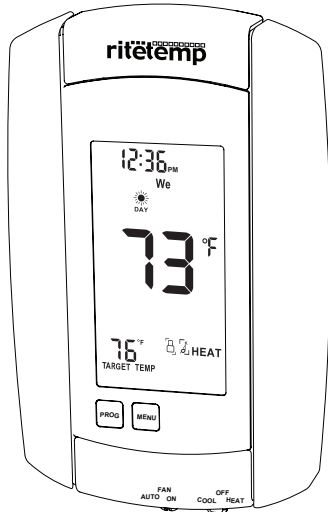

This thermostat uses a new technique called sequential staging for more comfort with faster reaction to requested temperature changes.

When using a heat pump with Auxiliary heat, if the heat pump cannot keep up and/or is defective, touch the MENU button, then touch PUMP; the PUMP OFF icon will come on.. The aux heat will then be your only source of heat. When the heat pump is again operational, be sure to turn the heat pump back on by touching MENU and then PUMP (off icon goes out) as the aux heat is more expensive than pump heat.

Wire Reference

PG 24

Your Wires Ritetemp Terminal

R or V or VR	RH and RC Single power for HEAT and COOL
RH or 4	RH Power for HEAT (RH not connected to RC)
RC	RC Power for COOL (RH not connected to RC)
W	W Heat control
W2	W2 2nd stage HEAT or heat pump auxiliary heat
?	A 3rd wire for zoned hot water heat (see zoned)
Y	Y COOL control
Y2	Y2 2nd stage COOL control
G or F	G FAN control
C or X	C Common 24VAC power (to power thermostat)
E	Emergency heat (do not connect, tape off)
L	System monitor (do not connect, tape off)
T	Outdoor sensor (do not connect, tape off)
B or	B Heat pump changeover (cool to heat, powered in heat)
O	O Heat pump changeover (heat to cool, powered in cool)
B and O	SEE NOTE

B and O

NOTE: If there are both B and O wires (Trane pump products) **DO NOT CONNECT B** to B terminal, connect B to C terminal

Wire Reference cont

Your Wires Ritetemp Terminal

Lennox Heat Pump
 V or VR or R RH
 M or Y Y
 Y or W or W2 W2
 F or G G
 R or O O
 X or X2 or C C

Trane Products [American Standard]
 B C
 W or W1 W2

Zoned Systems

Your Wires Ritetemp Terminal

2 wire Zoned Hot Water
 R RH
 W W

3 Wire Zoned Hot Water
 Motor Driven Valves
 R RH
 W W
 Y (the 3rd wire) A

3 Wire Zoned Hot Water
 Solenoid Valves
 R RH
 W A
 Y (the 3rd wire) W

Jumper Reference

Configuration jumpers allow your 6035 to be adapted to many different HVAC control applications.

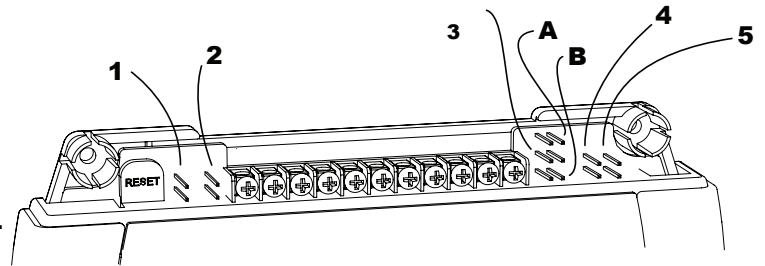

RESET UNIT AFTER CHANGING JUMPERS

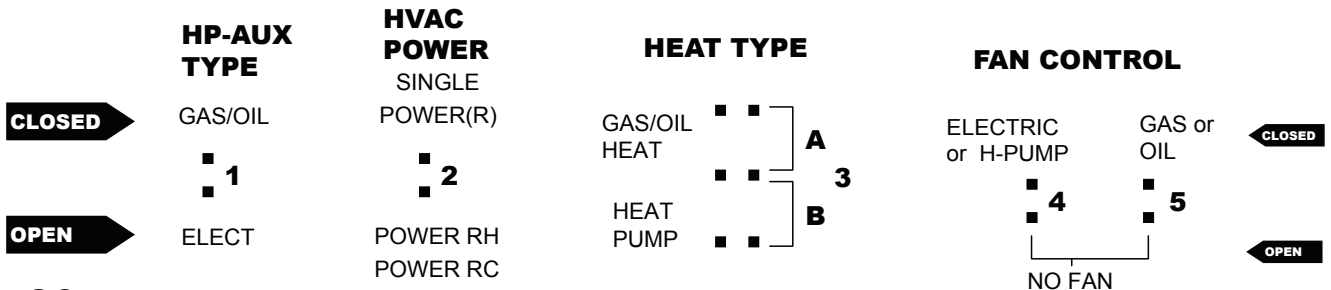

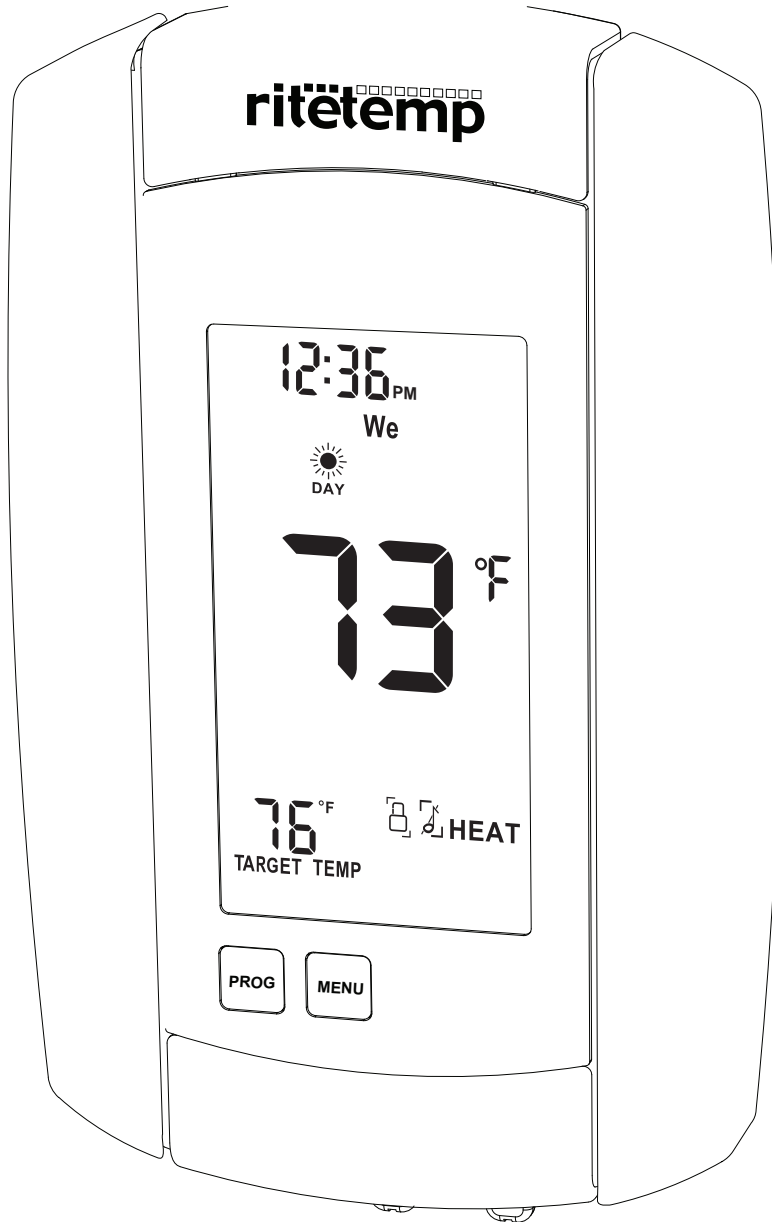

**Customer Support: 877-505-2353 or
Visit our website www.ritetemp-thermostats.com**

1611-026